

SAIC INSTRUCTIONAL SHOPS

Woodshop Authorization

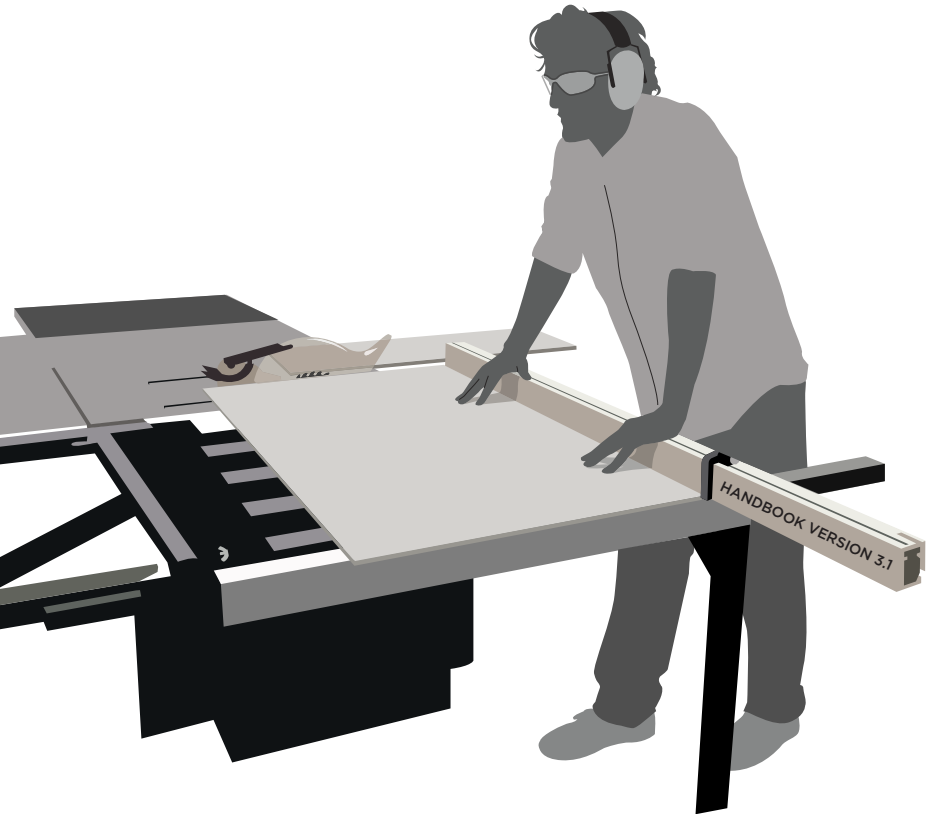

Access



Students currently enrolled in classes have access to the Shop and can checkout hand tools. However, in order to use stationary tools and other equipment, Authorizations are required.

Columbus Wood Shop

Open to all Undergraduate & Graduate students.

Sharp Instructional Shops

Open to students currently enrolled in Contemporary Practices.

Sullivan Fabrication Studio

Open to students currently enrolled in AIADO.

For more information, visit us online at saic.edu/instructionalfabrication

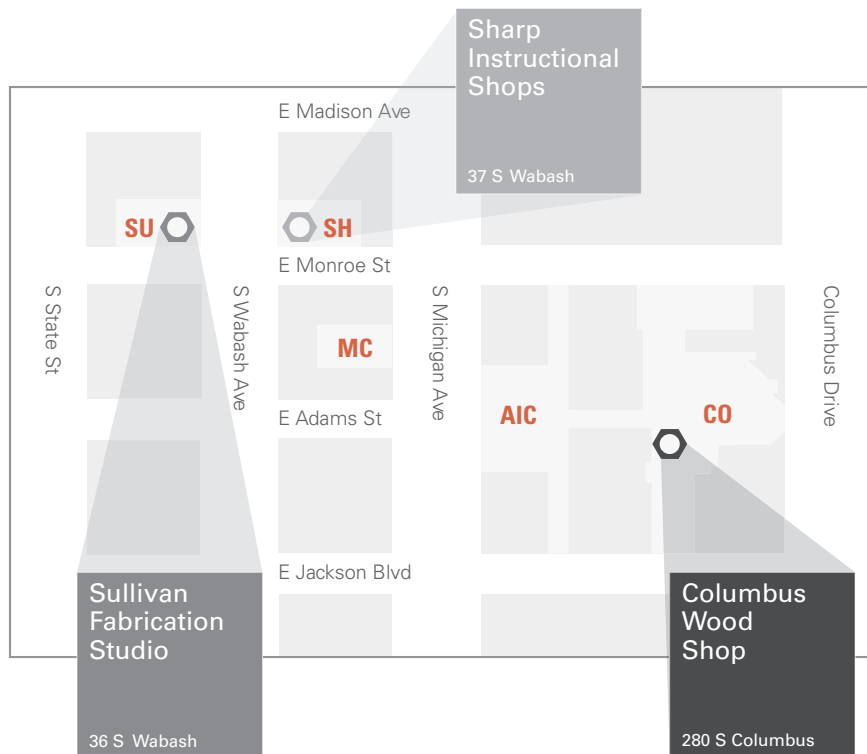

Authorization



The Woodshop Authorization includes a general shop orientation and instruction on the safe use of the Miter Saw, Drill Press, Band Saw, Table Saw, Jointer, Planer, and Stationary Sanders. Instruction and Authorization on all other stationary equipment is required prior to use, and quick process refreshers are available upon request.

Upon completion of the Woodshop Authorization, fill out and sign the Authorization & Handbook Review Acknowledgment Form located at the end of this book and return it to the Shop staff.

This Authorization will be good for two years.

Welcome.



The Instructional Shops is a creative forum for you to work cooperatively with staff and other artists to realize your concept and develop responsible working practices. The Shops are here to provide a safe and friendly learning environment, and an opportunity to work with manufacturing equipment and machinery.

This Handbook outlines basic policies and procedures, followed by all students and staff in the Instructional Shops. These policies are minimum acceptable standards. Every project has a different set of problems resulting in innumerable concerns. If you are uncertain about the best way to accomplish a task, please ask a member of the staff how to perform the necessary steps.

It is your responsibility to understand and abide by the procedures outlined in this handbook, and to follow any other instructions provided by the staff. Please read this Handbook and ask questions if you don't understand something.

Table of Contents



Instructional Fabrication's mission is to serve the contemporary art making needs of the School of the Art Institute of Chicago by providing instruction and technical assistance to students and faculty using the School's shops and fabrication facilities. Our staff work collaboratively across artistic and academic disciplines to support all manners of fabricating art objects.

Instructional Fabrication is a division within the department of Instructional Resources & Facilities Management (IRFM).

www.saic.edu/instructionalfabrication
facebook.com/instructional.fabrication

6	First Aid
6	Breathing & Ventilation
6	Reporting Safety Hazards
7	Getting Ready: Physical & Mental Condition
8	Getting Ready: Personal Protective Equipment
9	Best Practices
14	Introduction To Tool-Specific Procedures
14	Stationary Sanders
16	Bandsaw
18	Scroll Saw
20	Drill Press
22	Mortising Machine
24	Miter Saw
26	Jointer
30	Planer
34	Tablesaw

First Aid

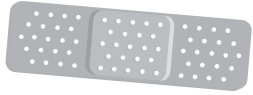

First Aid can be obtained from Shop Managers and at the SAIC Security Desk in all of the SAIC buildings. Students receiving first aid are encouraged to follow up with the SAIC nurse located at 104 S. Michigan Avenue.

Breathing & Ventilation



If you are using spray adhesives, spray painting, finishing, or engaged in advanced mold-making procedures; an organic chemical respirator should be considered a required accessory.

Reporting Safety Hazards



Report any possible defect in equipment or tools to a Shop Manager. The Shop Manager will take the tool out of service or keep the resource out of circulation until the problem is resolved.

Getting Ready, PART 1



PHYSICAL & MENTAL CONDITION

Stress, anxiety, sleep deprivation, low blood sugar, dehydration, and drug use (prescription, over the counter, or recreational) can interfere with your ability to work safely and effectively.

Anxious? In a hurry? Take a break or a moment to gather yourself. Most accidents happen when people are in a rush.

Sleep deprived? Lack of sleep severely limits our ability to problem solve and work safely. Sometimes a nap can make a big difference.

Medicated? Read and abide by any warning labels instructing against the use of machinery.

Drunk? Stoned? We must enforce a ZERO-tolerance drug and alcohol policy in the interest of the safety of all shop users. If caught indulging in drug use while in the shop, you may lose access to the Instructional Fabrication facilities for your duration at SAIC.

Getting Ready, PART 2

PERSONAL PROTECTIVE EQUIPMENT



EYES

The use of Safety Glasses is required at all times in the wood shop, and strongly encouraged when using power/hand tools in any capacity outside of the shop.



EARS

It is loud in the shop. Earplugs are provided free of charge, and their use is strongly encouraged. Headphones and cell phone use is not allowed.



HANDS

Gloves should not be used in any operation where there is the potential for entanglement, i.e. operation of any machine. Gloves can be useful in material handling, but not machine operation.

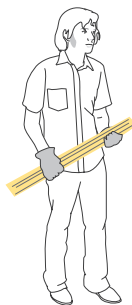

HAIR

Long hair must be pulled back, away from the face. If hair is especially long, it should be further constrained to avoid potential mechanical entanglement.



SHOES

Closed shoes only. No high heels, platforms, open-toed or open-heeled shoes, sandals, or flip-flops.



CLOTHING

There should be no loose clothing, long-sleeves must be rolled up, shirts tucked in, coats off, et cetera.



JEWELRY

Remove all accessories that could get caught in moving parts of equipment: rings, piercings, watches, ID card lanyards, scarves, et cetera.



BEST PRACTICES

When working with power tools, be mindful of the shop environment. Not following proper shop safety is dangerous. Take a moment and familiarize yourself with the following safe procedural and operational best practices. And above all, always ask questions if you don't understand something.



Wear safety glasses



Wear hearing protection



Use a dust mask

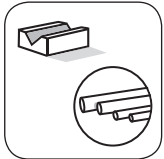

Use a V-lock to support dowels

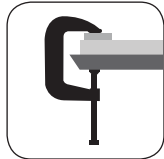

Secure your material

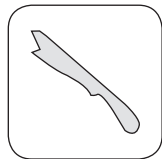

Keep push stick nearby



Keep fingers 4 or 6 inches from blade



Keep feet shoulder width apart, squarely on the floor



Beware of kickbacks

Procedural



Ask first. Refrain from doing anything you are unsure about.

Take frequent breaks while doing repetitive tasks.

Stay with your tool, never leave the tool while it's running.

Check the floor for slipping and tripping hazards.

Feed materials at a slow, even pace.

Keep materials flat on the table.

Set blade height to appropriate height, adjust guides accordingly.

Don't reach around, under, or over blades.

Make sure work area is clean and clear of obstructions.

Before backing out of a cut, turn the saw off and wait for the blade to stop.

Pliers, vises, or clamps are to be used to secure material or small work pieces. Stands can also be used to support materials.

Do not use found wood in the shop or anything with a prepared surface that can particalize.

Operational



Fingers need to be kept at least 4-6 inches away from blades and moving parts.

Always stand to the side of the blade in case of “kick back” (material is thrown backward).

Report any malfunction or strange noise immediately.

Don't try to stop a tool.

Always operate tools with both feet planted firmly on the floor, shoulder width apart.

Ensure the cut path is clear on the underside of material.

Always cut away from yourself.

Do not lock the tool in the *On* position.

If you have not been trained on a tool, do not use it.

Become well acquainted with the On/Off switch.

If the machine does not run smoothly, turn it off immediately and notify the shop supervisor.

Keep electrical cords and hoses out of walkways and away from heat, liquid, and sharp edges.

Use the right tool for the job.

Don't start a tool with material engaged in the cutting edge.

Tools are not to be used as general working tables.

Don't try to fix or disassemble tools.

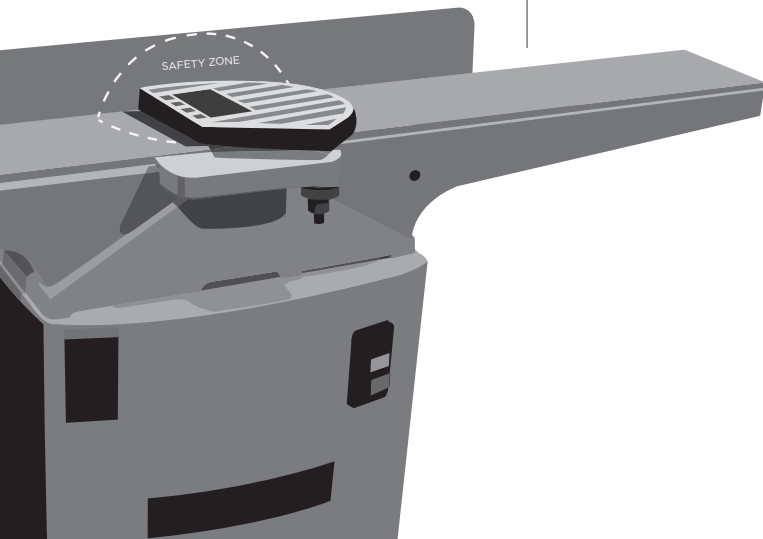

Introduction to Tool-Specific Procedures

The following section describes the basics of using stationary power tools. More in-depth training in safe use of equipment will be provided by the shop staff during authorizations and when needed. Woodworking machinery can be dangerous and should be treated with respect. Please read this section carefully and ask questions if you don't understand something.

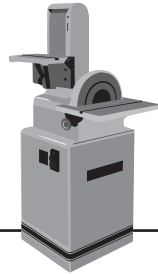

Stationary Sanders

WHAT TO KNOW

Stationary Sanders use abrasive components to quickly remove small amounts of material from exterior surfaces, and to smooth edges.

A **Disk Sander** is used to sand end surfaces quickly. It removes wood by turning an abrasive disc past a support table. Material is supported by the table and pressed against the abrasive disc.

A **Belt Sander** is generally used to

sand straight and convex surfaces. The belt sander removes wood by turning an abrasive belt past a support table. Material is supported by the table and pressed against the abrasive belt.

A **Spindle Sander** is used to sand interior curves. It removes wood by moving an oscillating abrasive spindle past a support table. Material is supported by the table and pressed against the abrasive spindle.

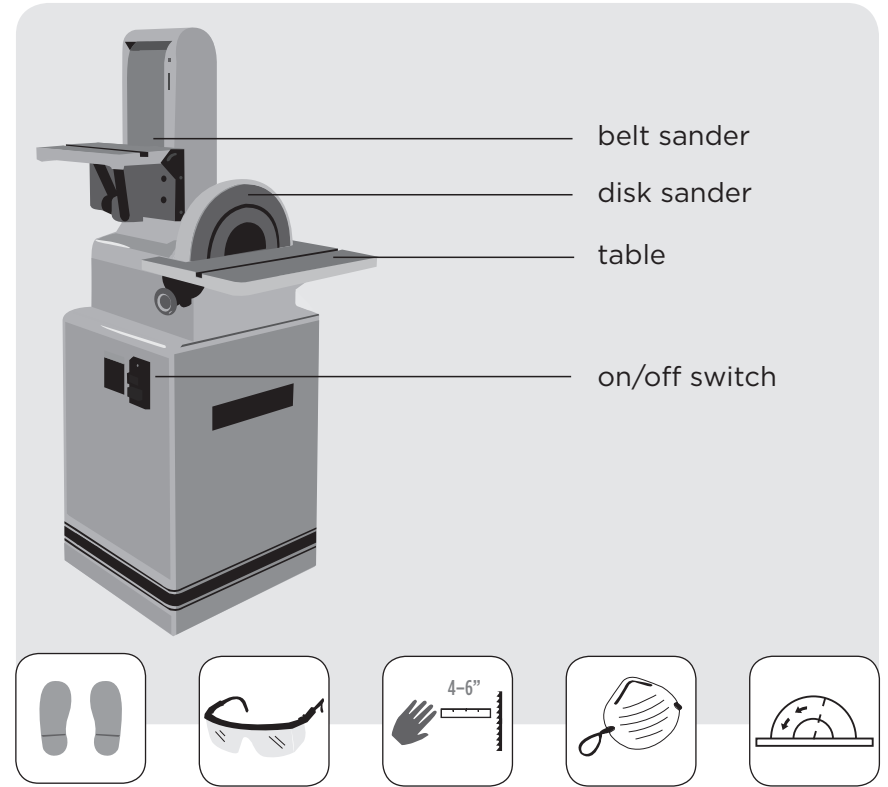

step by step:

1. Inspect the sander to make sure the abrasive component is in good condition.
2. Set and lock the support table at the desired angle.
3. Turn on the machine and wait for the motor to come up to speed.
4. Hold your work securely and flat to the table with your hands at least 4" away from the sander.
5. Turn the sander off and wait for it to come to a complete stop before making adjustments or walking away.

Band Saw

WHAT TO KNOW



The **Band Saw** is used to cut stock to size and to rough out shapes. The Band Saw cuts material with a vertical steel blade on a continuous loop. The blade rides on two wheels, which pull the blade through the table of the band saw.

Cuts may be made 'free hand' or with the aid of guides such as the rip fence or miter gauge. The material being cut needs to sit flat on the table in a stable manner, ie, no orbs or organic shapes that can rock.

step by step:

1. Set the blade guides to support the blade $\frac{1}{2}$ inch above the greatest thickness of the material to be cut.
2. Turn on the machine and allow the motor to come up to speed.
3. Begin cut. Feed the material at a slow steady rate. The thicker the material, the slower the speed. Let the blade do the cutting. Do not force the piece through the blade.
4. Use a push stick when the cutting operation requires your fingers to enter the 4" margin of safety. Keep push sticks within easy reach.
5. Do not twist the blade. Make relief cuts if the cut radius is less than the blade will allow.
6. When you are finished cutting, turn off the machine, depress the brake, and wait for the blade to come to a complete stop. Return the blade guide to its lowest position.

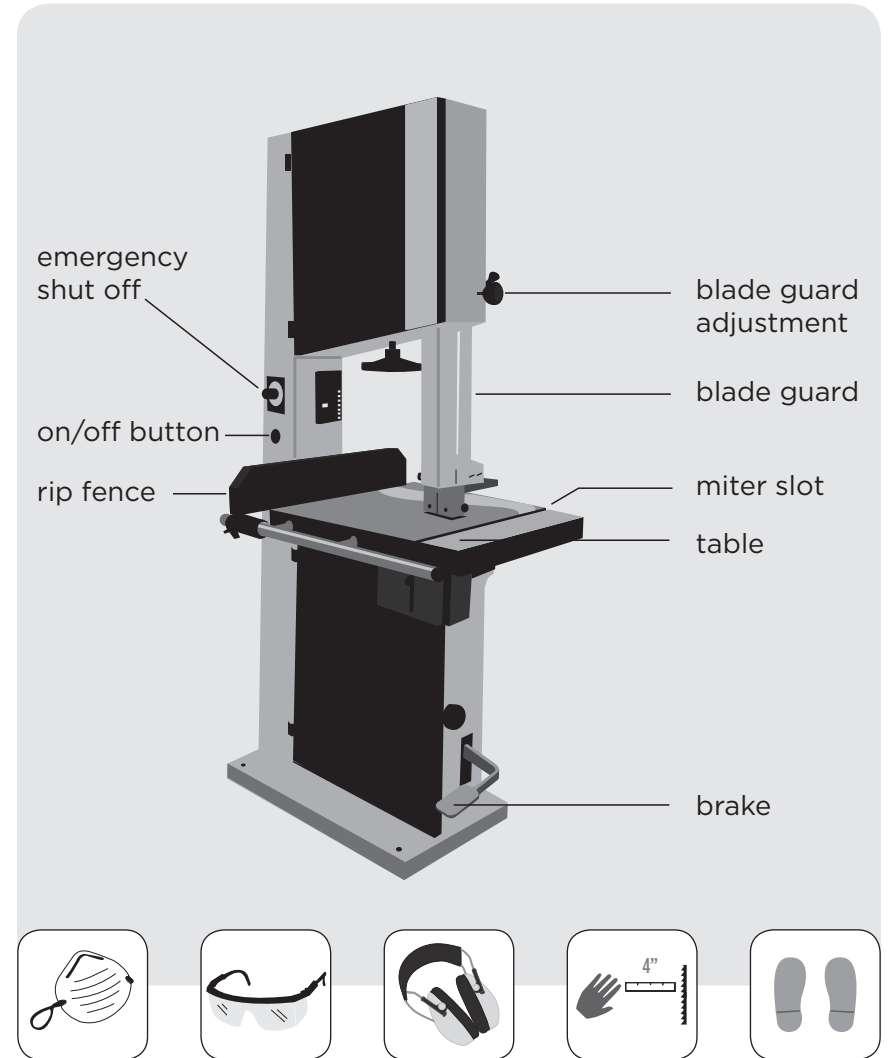

Scroll Saw

WHAT TO KNOW

The **Scroll Saw** cuts material with a short, thin steel blade that moves up and down through the table of the saw.

The scroll saw is used to cut tight freehand curves and intricate patterns in sheet stock. The removable blade is flexible and care must be taken to not break it when cutting. Because the blade is removable, it is possible to make closed interior cuts by passing the blade through a hole drilled into the wood.

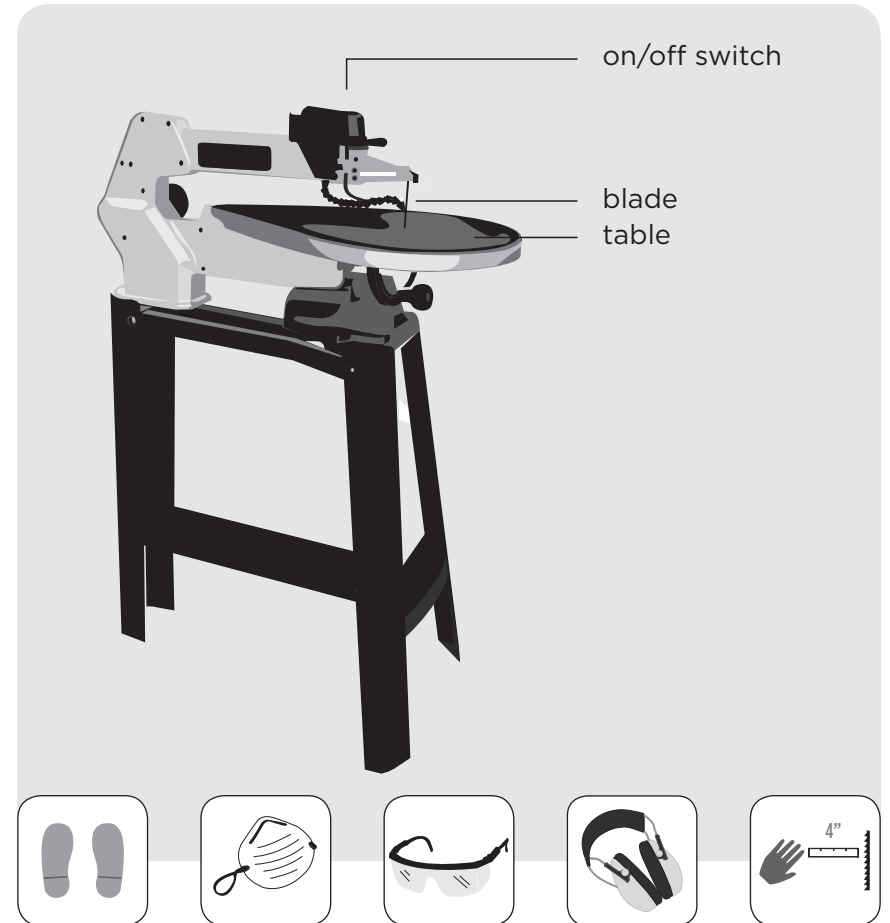

step by step:

1. With machine turned off, check the tension of the blade by plucking the back of it like a guitar. It should ring. Have a Shop Monitor change or adjust the blade if needed.
2. Adjust the “material presser foot” to hold the work piece in place, but not to restrict its lateral movement.
3. Disengage work piece from blade before turning on saw.
4. Turn on the machine and wait for the motor to come up to speed.
5. Approach the blade gently and take care not to break the blade while cutting. Adjust the speed as needed.
6. When you are finished cutting, turn off the saw and wait for it to stop before removing your work.

Drill Press

WHAT TO KNOW

Drill Presses are used to make accurate holes in a wide variety of materials. A drill press consists of an overhead drill mounted above an adjustable table. Much like a hand drill, the drill press uses bits that are held in place in a rotating drill chuck. With the aid of a chuck key, drill bits are interchanged as needed to fit the task.

The rotating drill chuck and bit are lowered into the work piece. The work piece and the table surface may be manipulated as needed.



step by step:

1. Install the desired drill bit in the chuck making sure that it is properly centered
2. Lock the bit in place with the chuck key. (Be sure to remove the key from the chuck before turning on the machine.)
3. Position and clamp the piece to be drilled flat on the table, or secure in a vice. (Make sure the bit will not damage the table or vice as it exits the work piece.)
4. Turn on the machine and wait for the motor to come up to speed.
5. Drill the hole.
6. Feed the drill by lowering the head assembly at a slow steady rate. The harder the material, the slower the speed—let the bit do the cutting.
7. When you are finished drilling, raise the head assembly to its full up position.
8. Turn the drill off, and wait for the chuck to come to a complete stop before removing the work piece or making any adjustments.

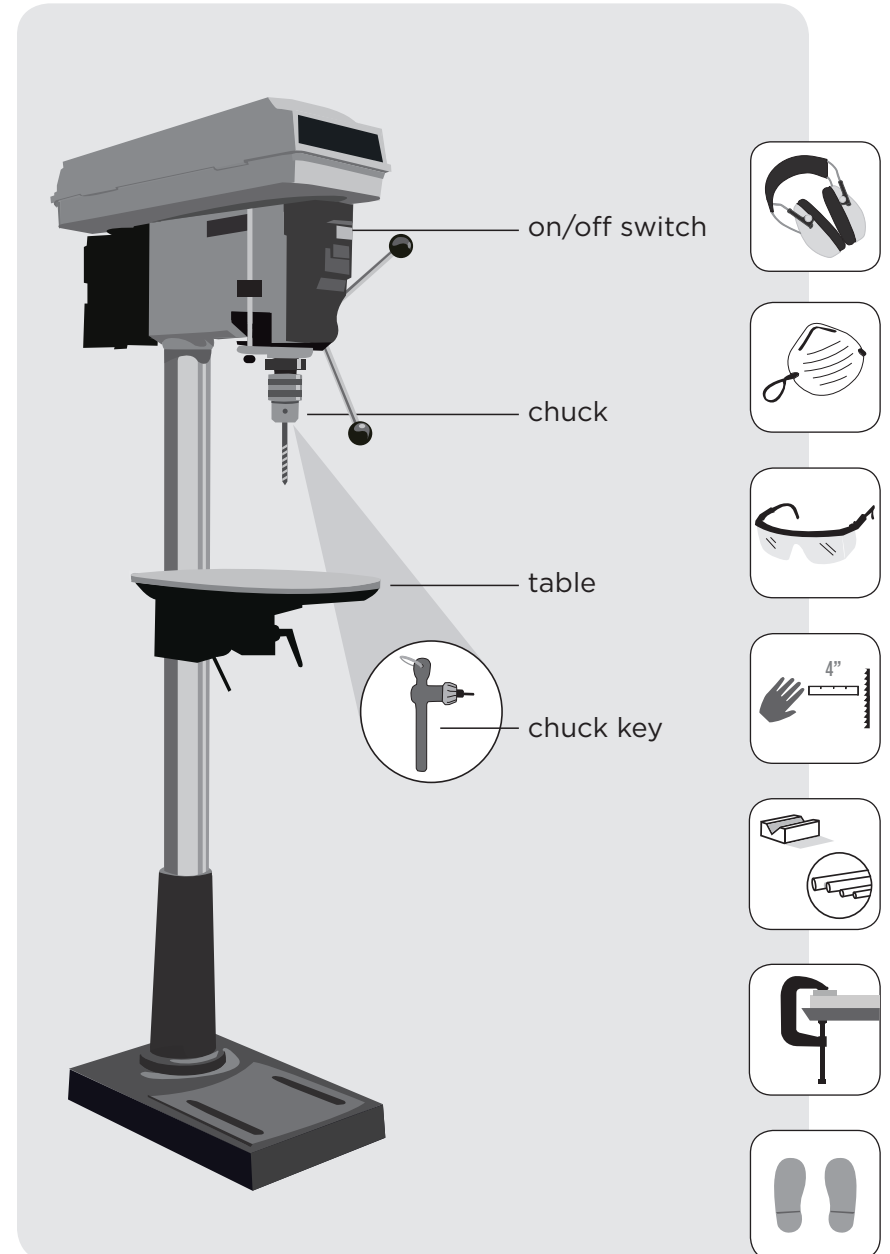

Mortising Machine

WHAT TO KNOW

The **Mortising Machine** drills square holes. The holes are cut into the wood with a drill bit inside of a square chisel. The mortising bit/motor assembly is supported above the work piece and are pressed into the material by the use of a lever. The work piece is secured with a built in clamp.



step by step:

1. With the assistance of Shop Staff, install the desired mortising bit in the chuck making sure that it is properly squared.
2. Position and clamp the work piece. Set all stops according to the size of the desired mortise.
3. Turn on the machine and wait for the motor to come up to speed.
4. Approach the material slowly by lowering the mortising head toward your work piece.
5. Feed the mortising bit at an even feed rate. Do a full plunge initially, then advance the length of the mortise by half bit widths per plunge.
6. When you are finished mortising, raise the head fully, turn machine off, and wait for the machine to come to a complete stop before removing the work piece or making modifications.

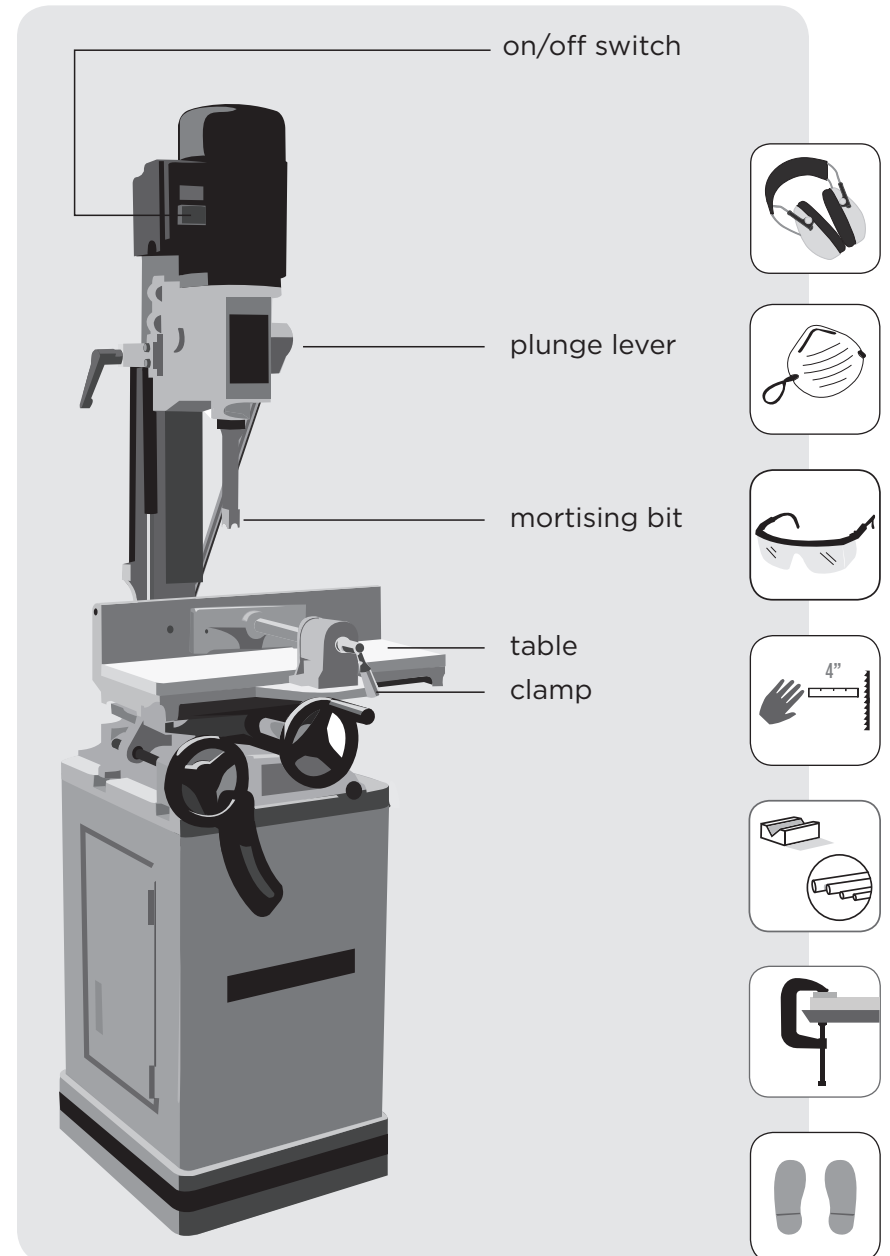

Miter Saw

WHAT TO KNOW

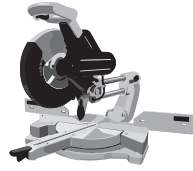

The **Miter Saw** (sometimes referred to as a chop saw) is used to cross cut linear stock to size and at accurate mitered angles. The miter saw is used to make through cuts. Only cut material that can be cut completely.

The miter saw cuts wood by turning a circular steel blade that turns downward and away from the operator. To produce a cut, the saw is lowered into the work piece, which is supported by the table and fence.

step by step:

1. Rest the material on the table and tight against the fence.
2. Set the angle to the desired position and lock the pivot into place.
3. Without turning the saw on, lower the blade to align it with your mark on your material.
4. Gently raise the saw all the way up. Do not release the saw suddenly.
5. Hold the material securely with your hand to the table and fence. Make sure that your hand is at least 6 inches away from the blade.
6. With the saw all the way up, firmly grip the handle, press and hold the switch.
7. After the blade has come up to speed, lower the saw slowly through the material.
8. When your cut is complete and the saw is all the way down, turn the saw off by releasing the switch, and wait for the blade to come to a complete stop.
9. Wait until the blade has fully stopped, then slowly raise the saw to its full upright position.

There are various kinds of Miter saws. Each is a little different to use:

- The **Compound Miter Saw** pivots and tilts on the vertical axis, cutting angles both on the top, and on the side of material.
- The **Sliding Compound Miter Saw** pivots, tilts, and slides on linear rails to give the saw a wider cutting capacity.

safety tip



NEVER cross your arms when using the miter saw.

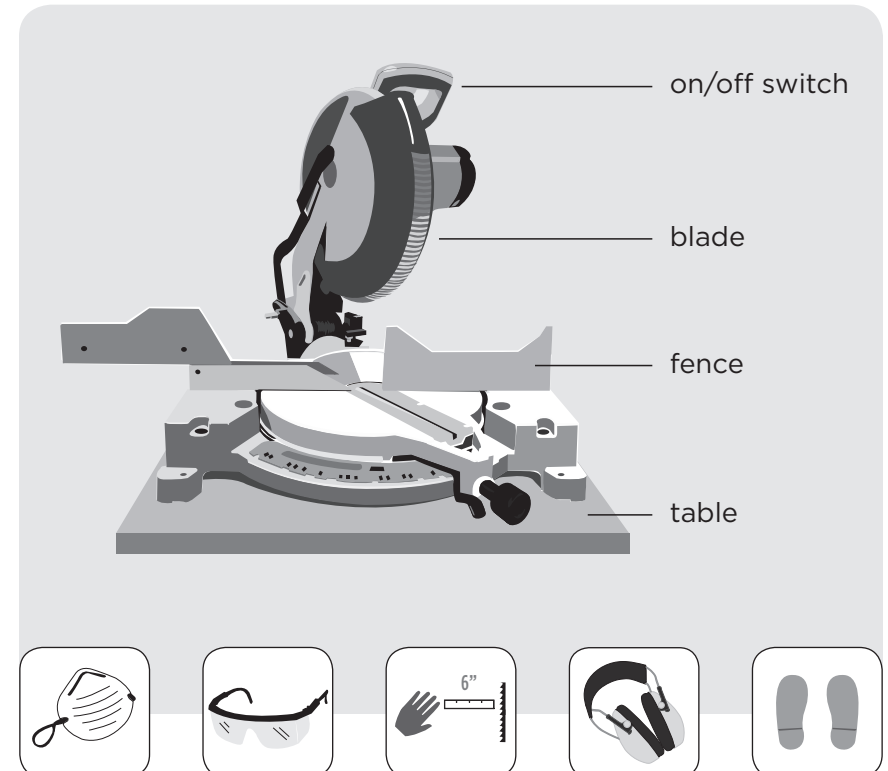

Jointer

WHAT TO KNOW

The **Jointer** is used to apply a smooth, even surface on a piece of wood. The jointer uses a sharp cutterhead to clean up rough-sawn, warped, or irregular edges of the board.

Always feed work along the length of the grain, from the infeed to the outfeed table (see illustration to the right). The jointer is only used for wood in the direction of the grain—material moves right to left.

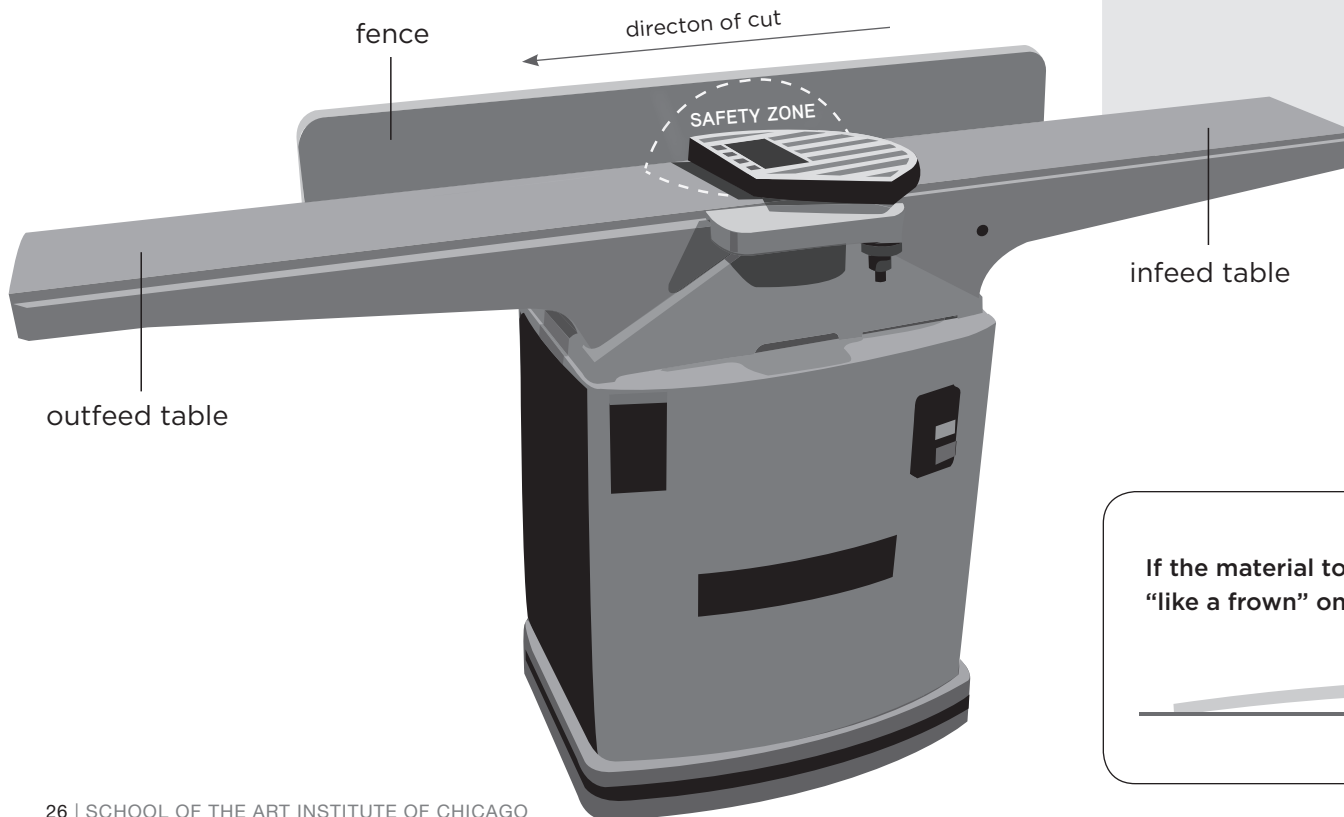
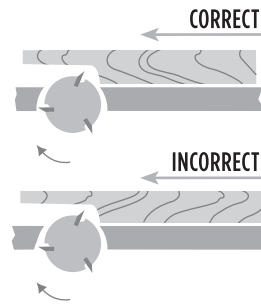

MATERIAL REQUIREMENTS

FACE JOINING: Do not use material shorter than 12", narrower than 2", or less than 1/2" thick.

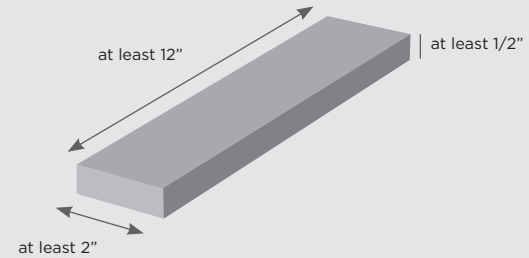

EDGE JOINING: Do not use material shorter than 12", narrower than 2", or less than 1/2" thick.

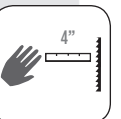
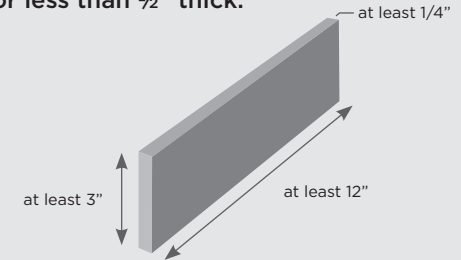

If the material to be jointed is bowed, it should be positioned "like a frown" on the table's surface.



step by step:

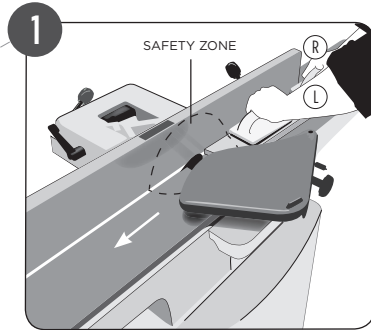

1. Locate the on/off switch.

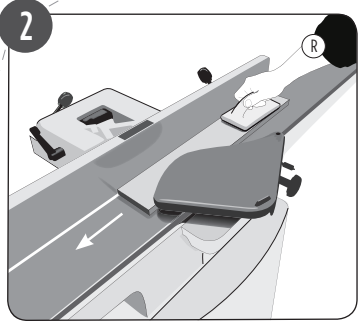

2. Always keep fingers outside of the 4" margin of safety. Use push pads if the jointing operation requires that your fingers enter the 4" margin of safety (above illustration).

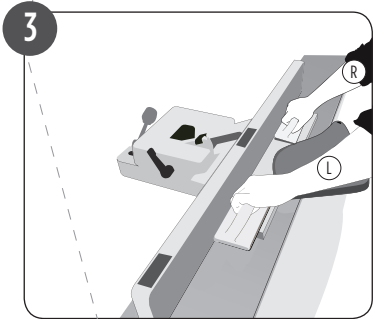

3. Press material firmly against the in-feed table bed and against the fence. Using even, steady pressure, move material from the in-feed table over the cutterhead to the out-feed table.

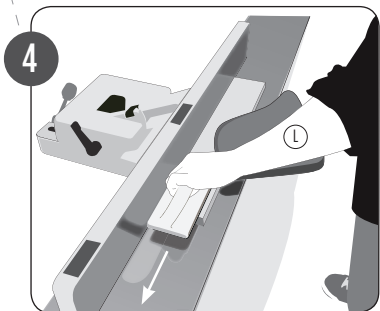

4. Once one foot of material is past the cutterhead, maintain steady pressure on the out-feed table.

5. When using the jointer on longer boards, use the support of a roller stand.

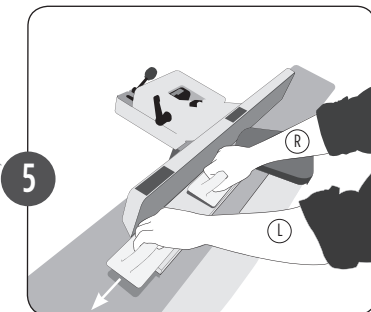

best practices



- Do not joint composite materials or end grains of lumber. (Examples: plywood, particle board, medex.)

- It is important to note that some adhesives can nick the cutterhead knives. Regular wood glue is soft and harmless to the knives, but should be thoroughly cured over night so as not to gum-up the machine.

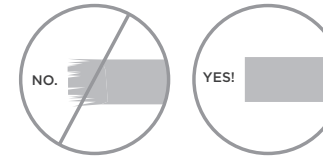

- No materials with mitered or shattered ends may be used on the jointer.

- Support the work piece at *all times* during operation.

- Always push material completely past the cutterhead and the guard to the outfeed table.

- Do not back material towards the infeed table.

- Never run your hands over the cutterhead knives.**

When jointing an edge, the board should be supported with the hands. Keep fingers on the top of the material and use your thumbs to hold the board flat to the fence. Keep fingers 4" away from the cutterhead.



Planer

WHAT TO KNOW

The **Thickness Planer** is used to create a consistent thickness and a smooth, flat surface on linear stock. The Thickness Planer removes wood by shaving material with blades on a rotating cylinder.

Material is supported by the bed and fed to the blade automatically. The thickness planer will not fix a board that is warped or twisted. Prepare one side of your material first with the jointer before bringing it to the planer.

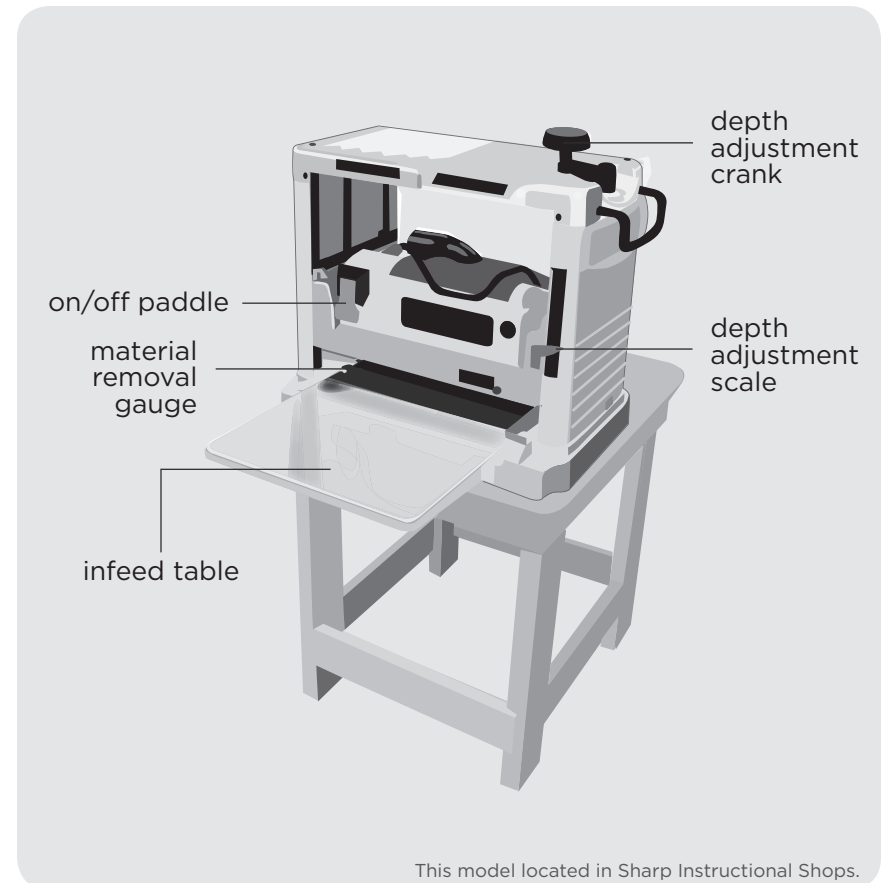
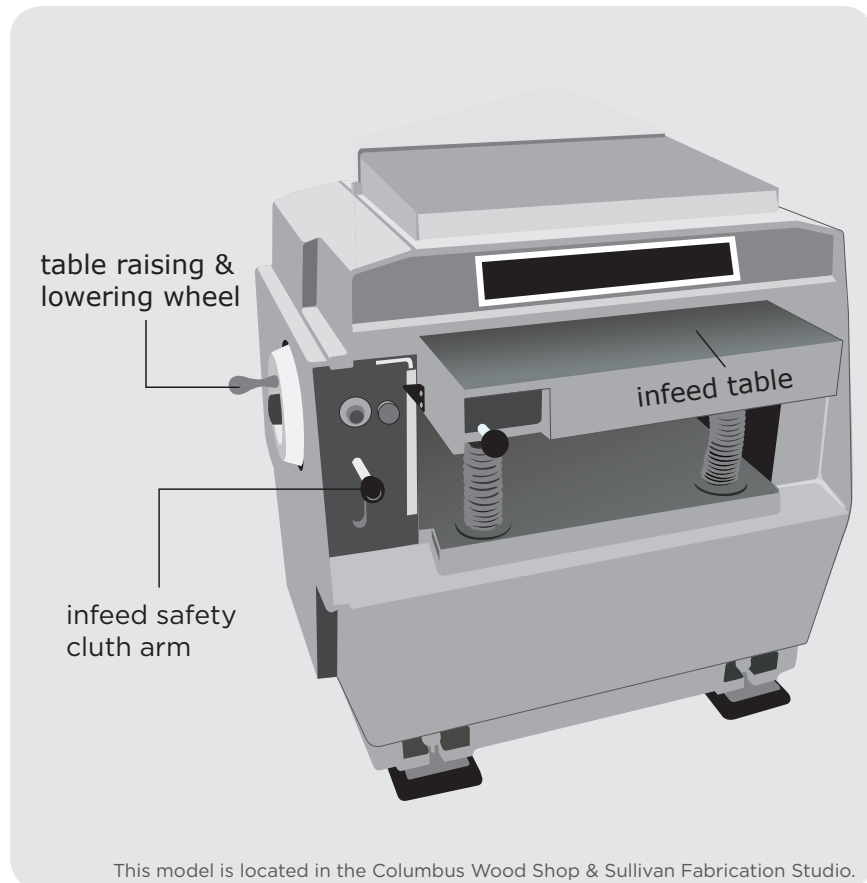
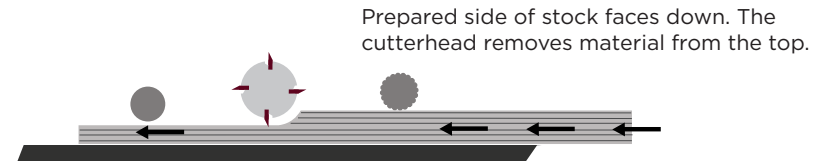
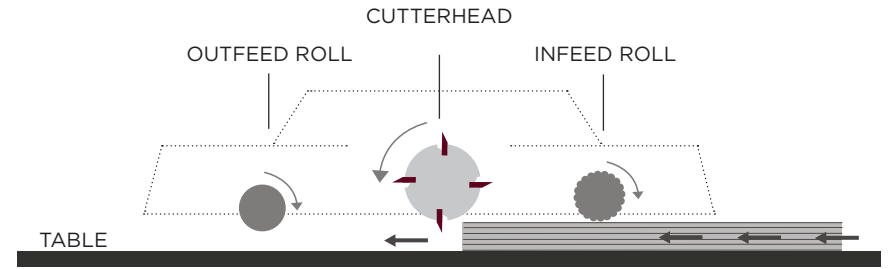

step by step:

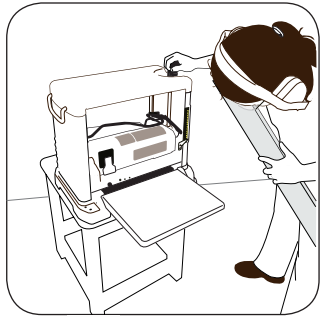

1. Measure your board at its thickest point. Set the planer to remove 1/16" (maximum) of material less than the thickest point.
2. Remove material from the machine before turning the machine on. Never start the machine with the material engaged.

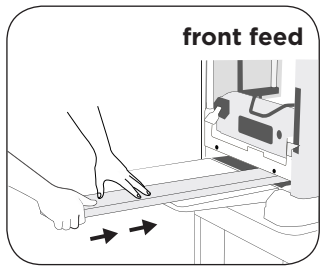

3. Introduce the board jointed side down on the table and square to the planer. If one end is thicker than the other, the thicker end should be fed first.
4. Gently feed the board in the direction of the grain to the planer. The planer will take the board from you and feed itself. Do not force feed it.

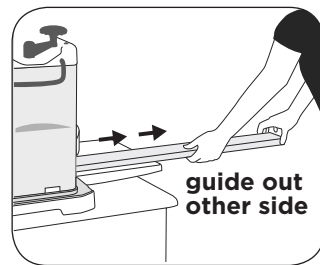

5. Support the board until half of the length is in the planer. Then walk around to the other side and support it until it completes the pass.
6. Turn the planer off and wait till it comes to a complete stop before making any adjustments or walking away.

best practices

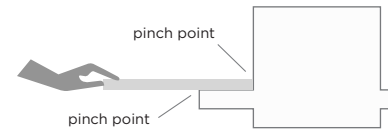
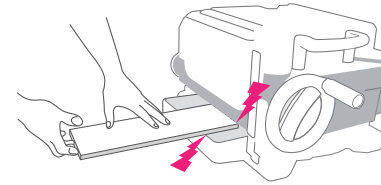

- Position hands to avoid "Pinch Points".
- Stock should have at least one flat surface to rest on the table.
- Keep hands at least 6" from the mouth of the planer at all times. Never put hands inside the planer.
- Do not use composite materials (Examples: plywood, particle board, medex.)
- If the planer stops or jams, turn it off and see shop staff for assistance.

MATERIAL REQUIREMENTS

Do not use material shorter than 12", narrower than 3/4", or less than 1/4" thick.

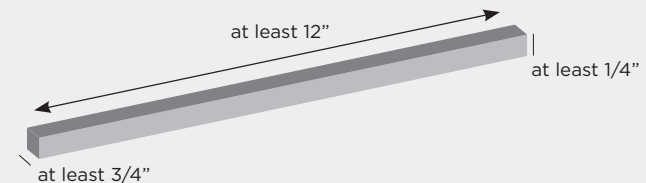

Tablesaw

WHAT TO KNOW

The **Table Saw** is used to make straight line cuts with the aid of either a fence or a miter gauge. The table saw is used primarily for making rip cuts and cross cuts. A rip cut is a cut made lengthwise through the stock. A cross cut is a cut made widthwise across the stock. Additionally the table saw is used to make bevel cuts, rabbet cuts, and dado cuts.

types of cuts

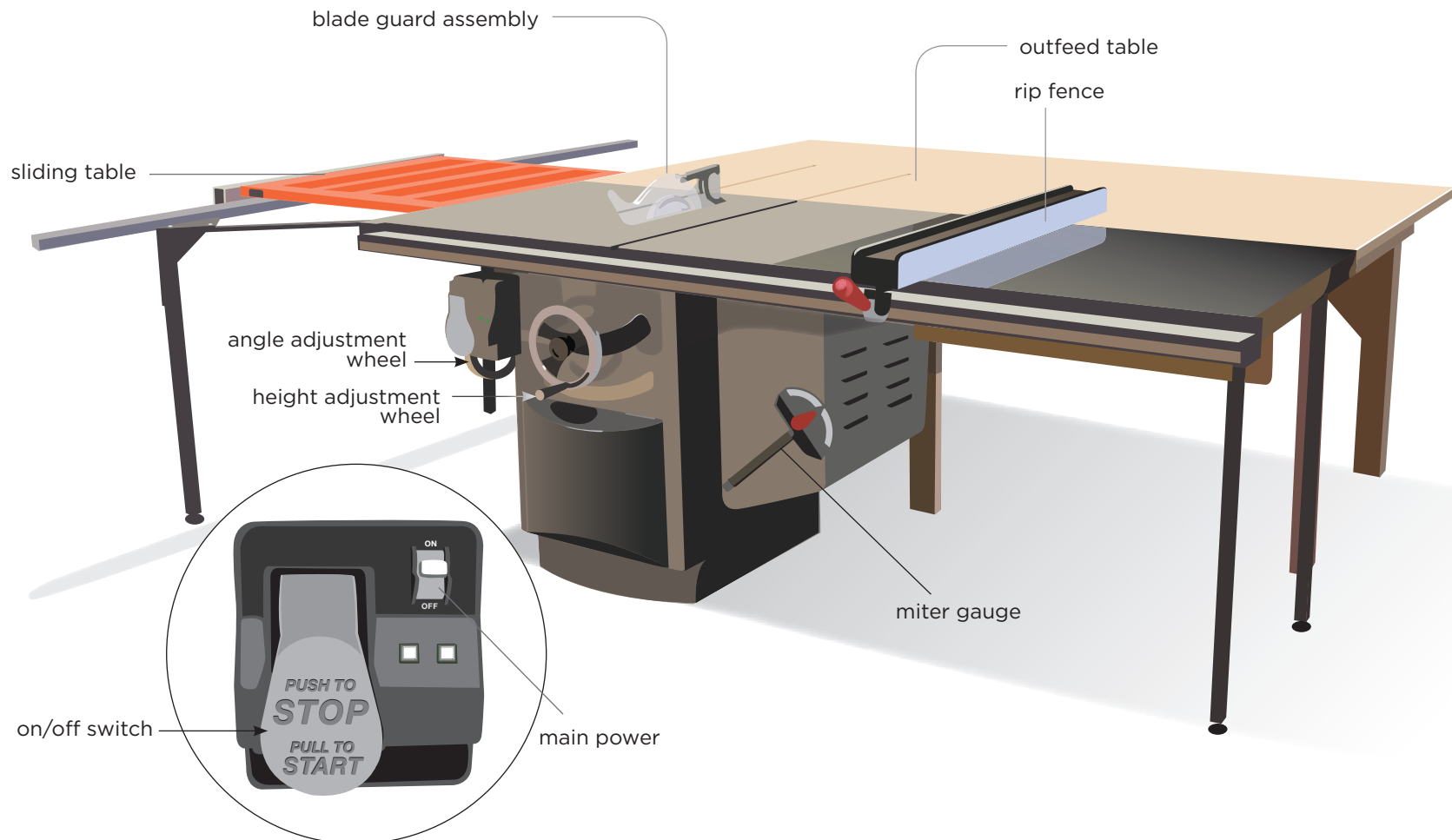
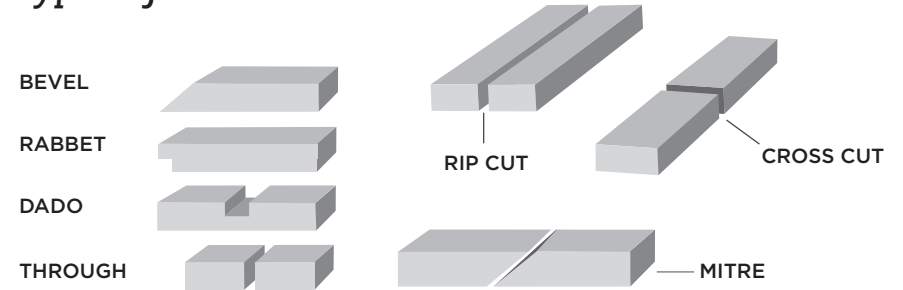

TABLESAW Blade

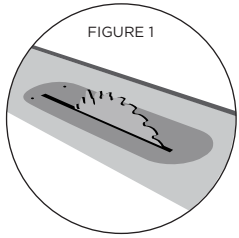

FIGURE 1

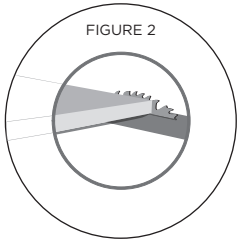
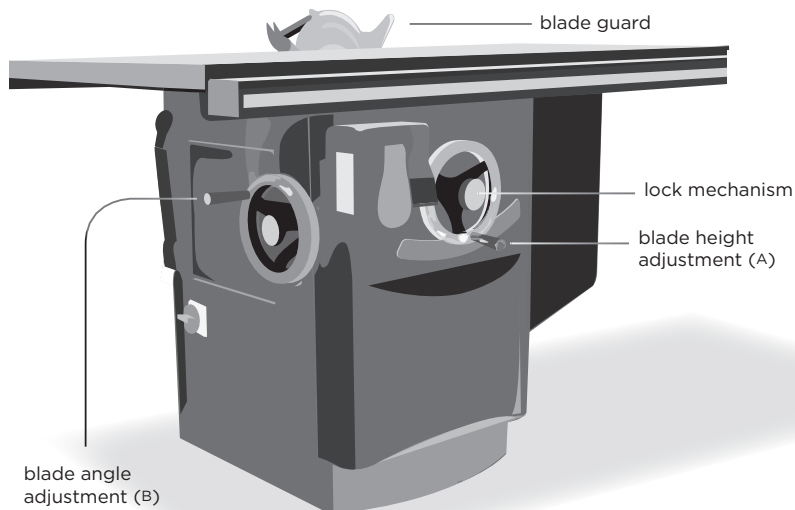
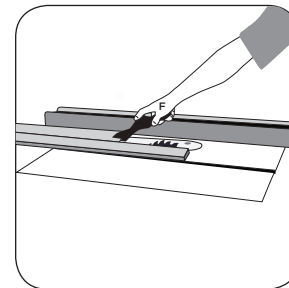
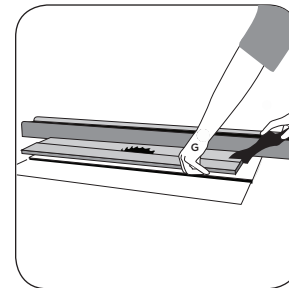
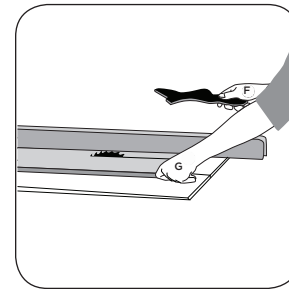
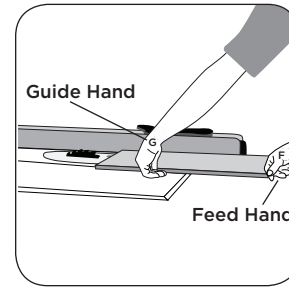

FIGURE 2

1. The table saw uses a 10" general purpose blade, 1/8 inch thick. The table saw blade and blade guards may only be changed by shop staff. The blade guard must be on at all times.
2. Raise the Blade Guard. Examine the two turning wheels below the saw. The knobs in the center of the wheels are lock mechanisms.
3. The wheel (A), located in front, raises and lowers the blade (FIG. 1). Raise the blade so that three entire gullets are exposed above the material (FIG. 2). Tighten the knob to lock it in place. The second dial to the right (B) is used to adjust the angle of the blade. Once the desired angle is set, tighten the knob to lock it in place.
4. It is important to check the angle of the blade before each cut. If the blade is not set correctly, you will not obtain an accurate cut. Do not rely on the built-in scale for accurate angle measurements.



Push Sticks



When the clearance between the blade and fence is too narrow to safely push materials through by hand, **Push Sticks** are used to feed material along the rip fence and complete a rip cut. A push stick allows you to keep your hand safely above the blade while working close to it. **A push stick should be used any time a rip cut requires that your hand be less than 4" from the blade.**

Push Stick Safety

- Never make a cut that requires you to cut the push stick.
- Never turn the push stick while cutting. Keep it in line with the blade.
- Position your body off to the side (facing the fence) so that if the stick is thrown, it may go past your body.
- Keep your fingertips at the shoulder of the stick, and clear of the blade.
- Push sticks should be held firmly but not with a tight fist, in case the stick is grabbed and thrown by the blade.
- Never run a push stick under a guard.

step by step: Making a Rip Cut

1. Set the blade angle and height and lock the fence into position. Place push sticks where you can reach them.

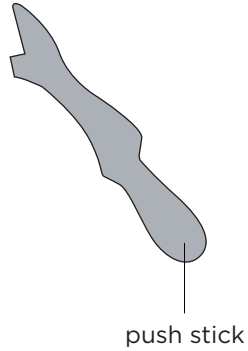

2. Turn the saw on and place materials at the edge of the table away from the blade. Maintain position on the infeed side of the machine during all operations. You should stand close to the saw and next to the material.

3. It is best to position yourself facing the blade side of the fence, so that you are pressing the material against the fence and into the table with your guide hand.

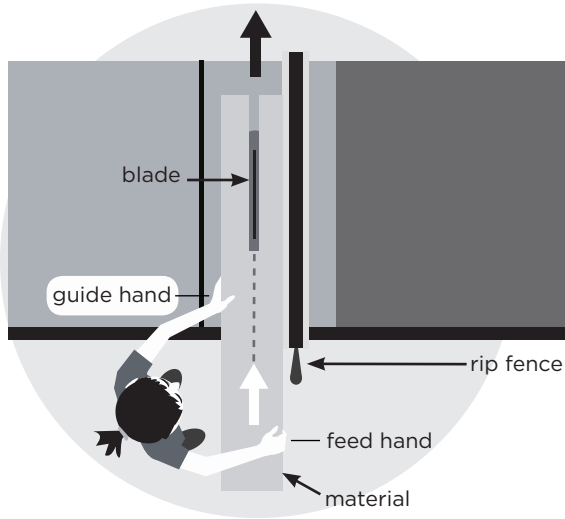

4. Maintain steady pressure on your work. Press it down toward the table and against the fence as you feed your material through the blade at a steady rate.

5. The hand that is used to support the material should not move. As your cut ends, feed the material completely past the blade guard assembly with your feed hand. Release the cut-off piece as it leaves your guide hand (below).

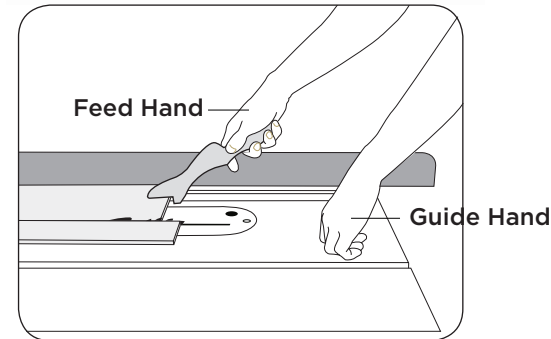

6. Do not reach over the moving blade to retrieve materials or try to remove scrap materials while the blade is moving—even when using a push stick!

Turn off the saw before you walk away.

The blade must come to a complete stop before removing material.

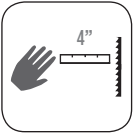

step by step: Making a Cross Cut

The miter gauge is used for cross-cutting.

1. Set the blade angle and height, and lock the guide into position.
2. Turn the saw on and place material at the edge of the table away from the blade.
3. Hold the wood against the miter head with the Guide Hand and use the Feed Hand to advance the miter gauge and wood through the cut. Ensure that your stock engages the entire face of the miter gauge.
4. When using a miter gauge, be sure to push the wood past the blade in a forward movement only. Dragging the wood back against the blade may cause serious injury.
5. Do not reach over the moving blade to retrieve wood or try to remove scrap wood while the blade is moving. Turn off the saw before you walk away. The blade must come to a complete stop before removing wood.

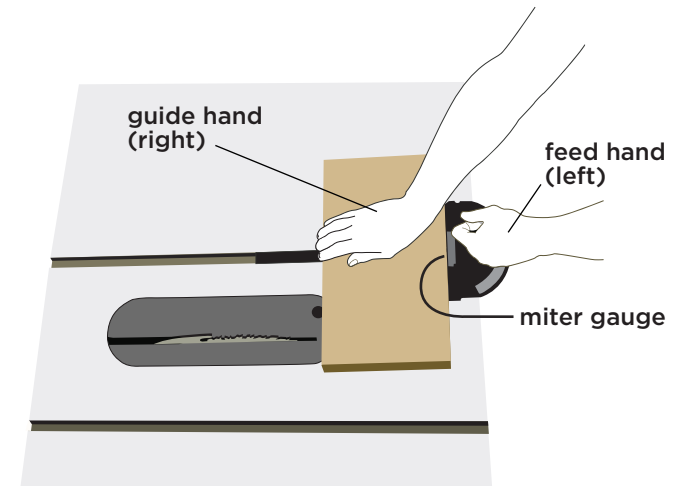
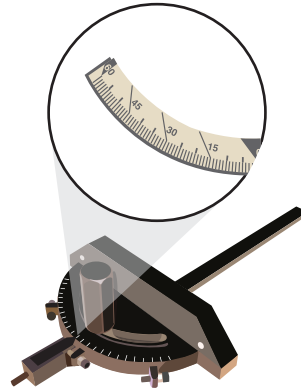

* Always hold the wood firmly against the miter head to prevent vibration and binding when the cut is made.

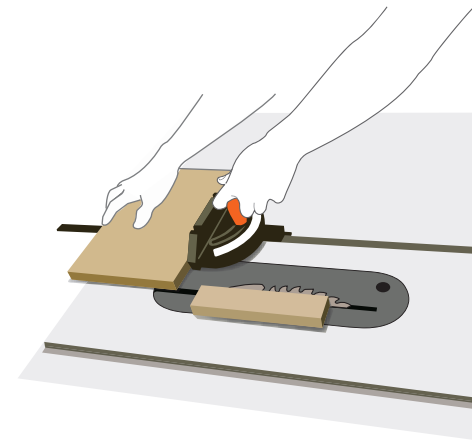

Sliding Fence

Another form of cross-cut can be performed with the sliding fence. This unit should be used for cutting materials larger than what the miter gauge can handle safely.

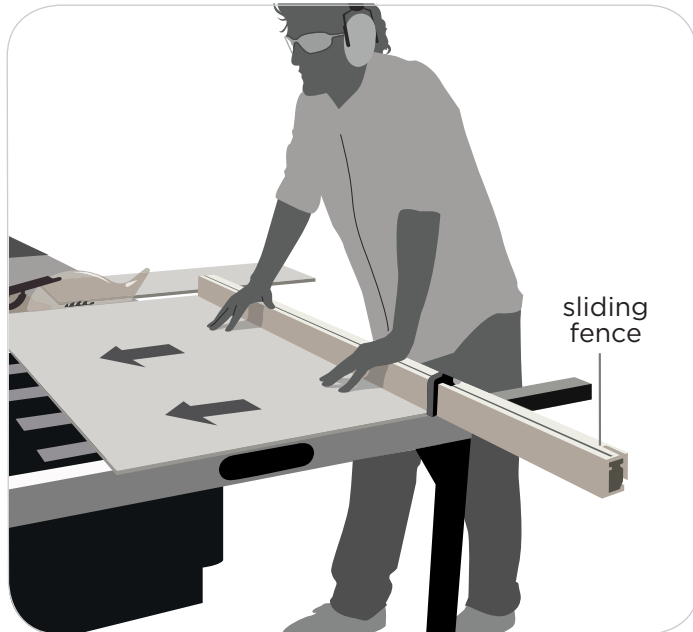

Dado Blade

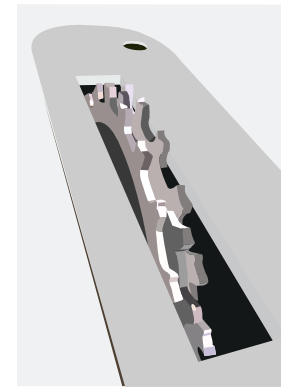

A **Dado Cut** is used for cutting a wide groove in the work piece or cutting a rabbet along the edge of a work piece. Shop staff will put the Dado Blade on the machine for you.

The Dado Blade is for slot cutting only, and should not be used to produce through cuts.

No blade guard is used. Set the blade to the depth you are cutting. When making a Rabbet Cut, use a sacrificial fence. It keeps the material from locking up.

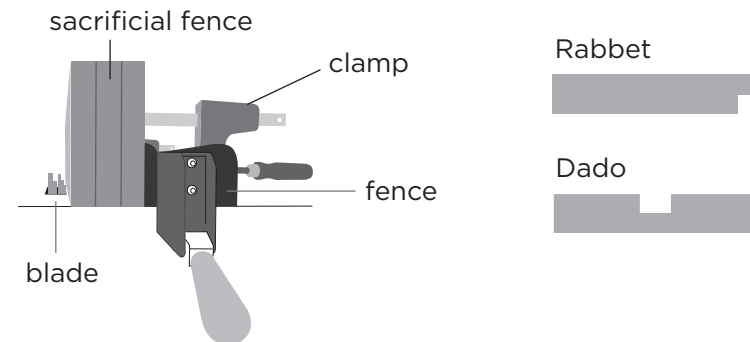

CAUTION: Kickback

Friction is created in any cutting process and is a necessary and inherent condition. Cutting tools are designed to function properly within an acceptable range of normal operating friction.

If friction between a material and the cutting tool becomes too intense, binding will occur. Typically when binding occurs, the **material will be thrown with great force in the direction that the blade is turning—this is called Kickback.**

Serious injury can result from kickback. Whenever possible, keep your face and body out of line with potential kickback, including when starting or stopping the machine.

Causes of Kickback

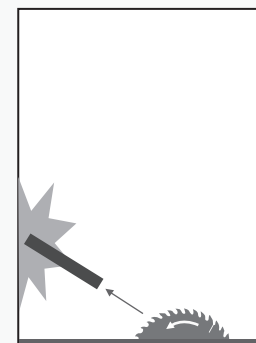

- Turning the material during the cutting process.
- Confining the cutoff piece.
- Not completing the cut or not pushing the work piece all the way past the saw blade.
- Not using the blade guard (splitter).
- Cutting warped or damaged material.
- Dull blades.
- Inappropriate material.

Notes

Notes

Wood Shop Authorization & Handbook Review Acknowledgment Form

I have attended the BASIC Shop Authorization training session and I have read and understand the BASIC Authorization Handbook. I have had the opportunity to ask questions concerning the training and the Handbook and all of my questions have been answered to my satisfaction.

I understand that I remain responsible for knowing and adhering to the School's Instructional Shop safety regulations and procedures. I understand that my safety and the safety of others using the Instructional Shop is dependent upon adhering to these safety protocols/procedures. I understand and acknowledge that if I fail to abide by the safety protocol/procedures outlined in this Handbook and presented in Equipment Authorization Workshop, I may be subject to disciplinary sanctions, including, but not limited to, fines and/or the loss of Instructional Shop privileges. Furthermore, I acknowledge that the School will not be responsible to me for any damage or injury caused by my negligence or willful misconduct. I understand that I am financially responsible for replacing lost or damaged equipment.

I further acknowledge that loss of privileges to use the Instructional Shop does not in any way excuse me from completing my course work on time.

I understand and acknowledge that it is my responsibility to test the equipment that I use and/or receive and that I must seek the pertinent instruction on proper use of a piece of equipment from Instructional Shop Staff or other authorized person before I attempt to use the equipment. If I encounter safety problems in the course of my work, I will discuss them with shop staff. I acknowledge that it is my responsibility to report any equipment malfunction or damage immediately to Shop staff.

Accepted & Agreed: _____

Name (please print): _____

Signature: _____

Date: _____

Student ID: _____

